

# Understanding Basic Analog – Active Devices

Ron Mancini

Mixed Signal Products

## ABSTRACT

This application report describes active devices and their use as the basic building blocks of all electronic equipment. Active devices, coupled with passive devices, create the combination needed to fulfill all circuit requirements. A select few active devices are discussed in this report.

## Contents

<b>Introduction</b> .....	<b>2</b>
<b>Bipolar Junction Transistor</b> .....	<b>2</b>
<b>Junction Field Effect Transistor</b> .....	<b>3</b>
<b>Metal Oxide Semiconductor Field Effect Transistors</b> .....	<b>4</b>
<b>Voltage Feedback Operational Amplifier</b> .....	<b>6</b>
<b>Current Feedback Operational Amplifiers</b> .....	<b>7</b>
<b>Voltage Comparators</b> .....	<b>8</b>
<b>Other Active Devices</b> .....	<b>8</b>
<b>Summary</b> .....	<b>9</b>

## List of Figures

1 BJT Description .....	2
2 BJT Model of an NPN .....	3
3 JFET Description .....	4
4 JFET Model .....	4
5 MOSFET Description .....	5
6 MOSFET Model .....	5
7 Voltage Feedback Op Amp Model .....	6
8 Current Feedback Op Amp Model .....	7
9 Voltage Comparator Model .....	8

## Introduction

Active devices have gain, thus they have transfer functions which are not available to passive devices. Active devices are considerably more complicated than passive devices; hence, their models and transfer equations are more complicated than those of passive devices. Active devices are the foundation on which all electronics equipment is built. Integrated circuits and higher forms of electronic components are built from the active devices discussed here.

## Bipolar Junction Transistor

The bipolar junction transistor (BJT) was the first active semiconductor device manufactured; therefore, it became the workhorse of the semiconductor industry. When the field effect transistor (FET) manufacturing process was perfected, it began competing with the BJT. Since then, the FET has been taking sockets from the BJT, but there are many applications, such as high frequency amplifiers, where the BJT still excels. Also, the BJT manufacturing process can be simple and inexpensive, and this, coupled with the BJT's long list of captured sockets, insures that the BJT will be around for a long time.

BJT transistors are made from a silicon bar that has three areas that are doped differently to produce the transistor. Doping means that the base semiconductor material has charged atoms added to change its polarity. These three areas are called the base, emitter, and collector. The emitter and collector are doped to have the same polarity which can be positive or negative, and the base is doped to have the opposite polarity. The BJT, like most transistors, comes in two types called NPN or PNP. P stands for positive, N stands for negative, and the positive or negative regions gain their name from the doping of the semiconductor material making up the base, collector, and emitter areas of the BJT. An NPN transistor has a positively doped base and a negatively doped collector and emitter.

An NPN transistor looks like two diodes with the anodes connected together (see Figure 1). The point where the anodes connect is called the base, one cathode is called the collector, and the other cathode is called the emitter. Although this illustration does not work with discrete diodes, it is fact in a BJT because when the width of the base junction is decreased enough, the back-to-back diodes function as a transistor. Using the back-to-back diode model, transistors are commonly checked for short circuits and open circuits with an ohmmeter. The base-emitter and base-collector junctions of a BJT act like forward biased diodes when the positive ohmmeter lead is connected to the base while the negative ohmmeter is connected to the emitter or collector. It looks like a reverse biased diode when the lead connections are reversed.

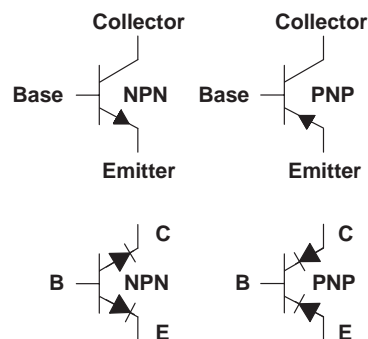

**Figure 1. BJT Description**

The small signal model of a BJT is shown in Figure 2. The input circuit, when the base is the input, looks like a forward biased diode; the input impedance equation is  $Z_{IN} = r_e = 26/I_C$  where  $I_C$  is in milliamps. The base-emitter junction must be forward biased, thus there is a forward voltage drop of  $V_{BE}$ .  $V_{BE}$  is approximately 0.6 volts in a silicon transistor, and 0.2 volts in a germanium transistor. The input current is called  $I_{base}$  or  $I_B$ .

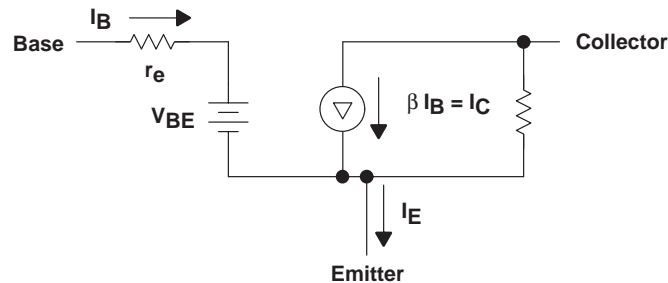

Figure 2. BJT Model of an NPN

Since the collector-base junction is reverse biased, the collector current flows from the collector to the emitter. The collector current equation is  $I_C = \beta(I_B)$  where  $\beta$  is the current gain of the transistor, and the emitter current equation is  $I_E = I_C + I_B$ . The impedance of the collector-emitter junction is called  $r_c$ , and  $r_c$  is very a high value (in the  $M\Omega$  range). Current gain and the forward voltage drop are a function of the manufacturing process, temperature, and device physics, hence they are not stable parameters. Therefore, BJT circuits that depend on  $\beta$  and  $V_{BE}$  are not stable; thus, in well designed BJT circuits, the external components stabilize these parameters with feedback. This is not a drawback with just BJTs; this same condition exists for all transistors.

## Junction Field Effect Transistor

The junction field effect transistor is called the JFET, and it comes in two flavors, p-channel and n-channel. It has high input impedance at the gate, so the JFET is often used in the input stage of amplifier circuits. The JFET has a high bandwidth, but circuit topologies and parasitic capacitors prevent it from achieving the same high bandwidth circuits where the BJT excels. The JFET can achieve high bandwidth when its output is limited to small signal swings which are characteristic of input circuits. JFETs and BJTs can be made simultaneously on a semiconductor process called BIFET, thus they are often combined to make a high input impedance, high bandwidth amplifier. The JFET output impedance is high in the off state and low in the on state.

The JFET can be visualized as a bar of doped silicon that has a diode junction made in the middle of the bar. If the silicon bar is doped N, the JFET is called an N-channel device. Figure 3 shows the symbols for n-channel and p-channel JFETs. When the n-channel gate is negative with respect to the source the diode is biased off, the bar is depleted of carriers, and the source to drain resistance is quite high (several  $M\Omega$ ). When the n-channel gate is biased positive with respect to the source, the diode is biased on, and the bar is flooded with carriers thus causing a low source to drain resistance (as low as  $m\Omega$ ). The converse is true for a p-channel JFET.

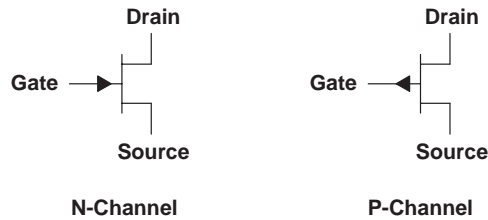

**Figure 3. JFET Description**

The linear JFET model is shown in Figure 4. When the JFET is biased in its pinchoff region, the gate is represented as an open circuit because the input diode is reverse biased. The drain to source current is a voltage controlled current source,  $g_m(V_g)$ . The output resistance is modeled by  $R_O$ . As long as the signal swings stay in the pinchoff region, the gate-source voltage signal swing induces a drain-source current flow. Again, as is the case with the BJT, the key parameters of the JFET such as gain are temperature and drift sensitive, so feedback is used to make JFET circuits dependent on stable passive components.

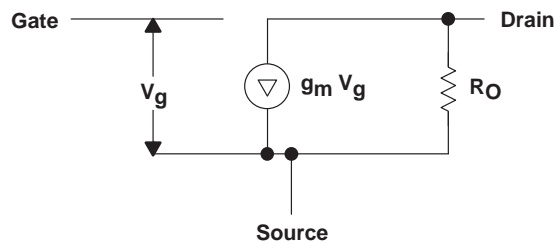

**Figure 4. JFET Model**

## Metal Oxide Semiconductor Field Effect Transistors

The BJT and JFET have a diode in their input circuit which controls their mode of operation. The metal oxide semiconductor field effect transistor (MOSFET) works on a similar principle, but the diode is buried within the MOSFET. The MOSFET input diode is controlled by an electric field in the gate region, thus the input impedance is always extremely high because there is no forward biased diode to lower the input impedance. The input impedance of MOSFETs is so high that there is no mechanism that readily bleeds off the accumulated charge except for humidity, thus they are often packaged with lead shorting wires to drain the charge. The lead shorting devices protect the MOSFETs from charge buildup and the subsequent catastrophic discharge current. All semiconductor devices should be protected from static discharge, but MOSFETs are the most liable to build up a killing charge. Do not be lax with static protection because some sensitive BJTs are affected by only a few hundred volts static discharge.

The MOSFET is a majority carrier device, and because majority carriers have no recombination delays, the MOSFET achieves extremely high bandwidths and switching times. The gate is electrically isolated from the source, and while this provides the MOSFET with its high input impedance, it also forms a good capacitor. Driving the gate with a dc or a low frequency signal is a snap because  $Z_{IN}$  is so high, but driving the gate with a step signal is much harder because the gate capacitance must be charged at the signal rate. This situation leads to a paradox; the high input impedance MOSFET must be driven with a low impedance driver to obtain high switching speeds and low bandwidth.

MOSFETs do not have a secondary breakdown area, and their drain-source resistance has a positive temperature coefficient, so they tend to be self protective. These features, coupled with the very low on resistance and no junction voltage drop when forward biased, make the MOSFET an extremely attractive power supply-switching transistor.

The MOSFET (see Figure 5 for a description) can be visualized as a bar of doped silicon that contains a capacitively coupled diode junction in the middle of the bar. If the silicon bar is doped N, then the MOSFET is called an N-channel device. When the n-channel gate is charged negative with respect to the source the internal gate diode is biased off, the bar is depleted of carriers, and the source to drain resistance is quite high (several hundred  $M\Omega$ ). When the n-channel gate is charged positive with respect to the source, the internal gate diode is biased on, and the bar is flooded with carriers thus causing a low source to drain resistance (in the low  $m\Omega$  range). The converse is true for a P-channel MOSFET.

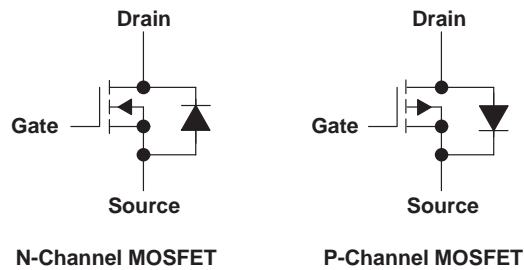

**Figure 5. MOSFET Description**

The linear MOSFET model is shown in Figure 6. When the MOSFET is biased in its linear region, the gate appears as an open circuit to dc. The drain to source current is derived from a voltage controlled current source,  $g_m(e_g)$ . The output resistance is modeled by  $R_O$ . As long as the signal swings stay in the pinchoff region, gate-source voltage signals induce a drain-source current.

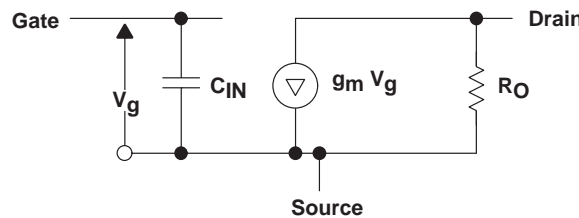

**Figure 6. MOSFET Model**

The MOSFET contains a diode connected across from the drain (cathode) to the source (anode). This diode is not forward biased during normal operation, consequently it does not conduct current during normal operation. When the MOSFET is connected to an inductive load, the inductive kick causes the diode to turn on and conduct current. In some modes of operation, this is a desired effect because it limits the inductive voltage rise. The diode is not a fast turn-off diode, so it consumes quite a bit of power during turnoff. The turnoff power consumption is detrimental in some circuits, thus those circuits must put a diode with a smaller forward voltage drop (Schottky diode) in parallel with the body diode.

$C_{IN}$  can be as large as several hundred pF, and it must be charged by the gate signal. When the MOSFET is used in a power switching application, the gate is normally driven by a low impedance driver so that  $C_{IN}$  can be charged quickly. If  $C_{IN}$  is charged slowly, the switching time of the MOSFET is long causing the MOSFET to stay in the linear region for a long time. When the MOSFET operates in the linear region, its voltage drop and current flow are high, resulting in high power dissipation.

Again, as is the case with the BJT, the key parameters of the MOSFET such as gain are temperature and drift sensitive, so feedback is used to make MOSFET circuits dependent on stable passive components.

## Voltage Feedback Operational Amplifier

The voltage feedback operational amplifier (VF op amp), or op amp as it is affectionately known, is a versatile amplifier which requires feedback to function. The op amp gain is so high that the output saturates on any differential input signal, so feedback is employed to lower the closed loop gain. The feedback makes the op amp circuit a precision circuit because the closed loop gain is dependent on the passive components which can be very accurate. Some op amp parameters, such as input offset voltage can still degrade precision, but there are specially designed precision op amps that have very low input offset voltages (micro volts), and selected salient parameters chosen to yield a precision circuit. The differential input structure of an op amp enhances precision because the transistors in both inputs can be matched.

Op amp bandwidth depends on the process used to make the op amp, and BJT op amps have the highest bandwidth and current drain, with JFET op amps are next highest, and MOSFET op amps have the lowest bandwidth and current drain. Voltage feedback op amps are discussed in this section, and their bandwidth starts rolling off at low frequencies (about five decades before the advertised gain-bandwidth point).

The input impedance of the op amps is very high, and their output impedance is relatively low, thus they are ideal for configuring many different circuits. Some of the possible circuits op amps make are inverting amplifiers, noninverting amplifiers, differential amplifiers, summing amplifiers, and integrating amplifiers. The op amp model is shown in Figure 7. The input impedance of op amps is very high, and it is often modeled as an open circuit. The output circuit consists of a voltage controlled voltage source, and the control voltage is the differential voltage applied across the inputs.

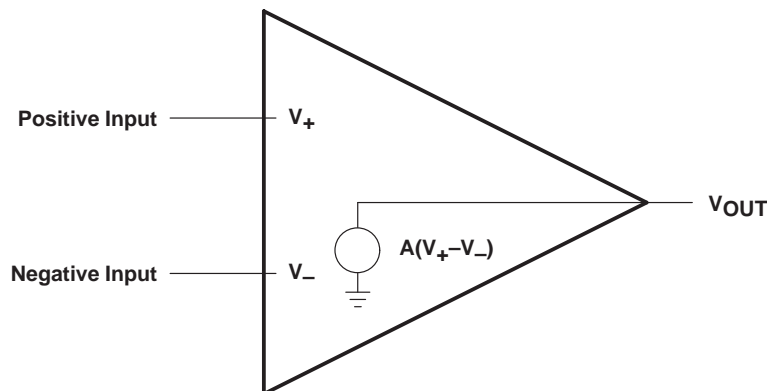

**Figure 7. Voltage Feedback Op Amp Model**

Op amps are always surrounded with passive components, which are required to program the gain and add stability.

## Current Feedback Operational Amplifiers

Current feedback op amps, called CFA for current feedback amplifier, are also called op amps, hence there can be confusion about which type of op amp (voltage or current feedback) is under discussion. It is assumed that voltage feedback op amps are being discussed unless a reference is made to the current feedback op amp (CFA).

The CFA configuration makes it hard to achieve precision because there is a buffer tied across the inputs. The input structure of a CFA is not matched, hence it is hard to obtain dc precision, which requires a matched input structure (usually a differential amplifier is used when matching is required). The applications for CFAs generally do not require high precision because CFAs are used in high frequency circuits. In many high frequency circuits, the dc portion of the signal contains little or no information, thus precision is not paramount in these applications.

CFAs are usually made with BJTs because they yield very high bandwidths. The high bandwidth of a CFA does not start rolling off till much higher frequencies (several decades higher) than a VFA does, but it rolls off at a much faster rate. CFA have bandwidths in the GHz range while VFA bandwidths are down in the several hundred MHz range. The input impedance of CFAs is high for the positive input and low for the negative input because of the input voltage buffer.

The CFA model is shown in Figure 8. The positive input is a voltage buffer input, so the positive input has very high input impedance. The negative input is connected to the output of the same voltage buffer, hence the negative input impedance is close to zero. It is very hard to match parameters between the inputs because they are connected to different ends of a buffer, and this situation makes it hard to build precision CFAs.

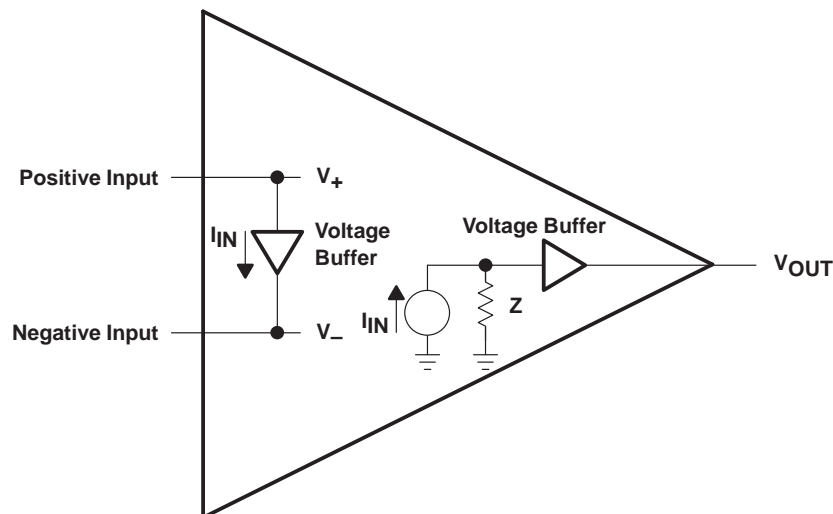

Figure 8. Current Feedback Op Amp Model

The output circuit contains a transimpedance stage,  $Z$ , so the error current which flows through the input stage  $I_{IN}$  is multiplied by  $Z$  to form a voltage. This voltage is buffered before it becomes the output voltage, thus the CFA has very low output impedance.

## Voltage Comparators

The voltage comparator is used to convert an analog signal to a digital signal. This is usually accomplished by connecting a reference to the negative comparator input and a signal to the positive comparator input. When the signal exceeds the reference the output goes from a low voltage (a logic zero) to a high voltage (a logic one). Inverted operation can be obtained with a comparator by reversing the inputs.

The input stage of a comparator is similar to an op amp input stage. The differential input voltage is multiplied by the gain to obtain an output signal. The comparator gain is very large, and it is not limited by feedback, so the output would saturate if it was an op amp. The difference is that the comparator has an output stage that reaches a limit but does not saturate. The comparator's ability to run open loop without saturating separates it from the op amp which always saturates when it runs open loop. Never use op amps for a comparator function when propagation delay is important, because when an op amp saturates, the time needed for it to come out of saturation is unpredictable.

The voltage comparator is shown in Figure 9. The voltage comparator input stage is identical to a VF op amp input stage, consequently the comparator input impedance is very high. The inputs can be matched very well, thus comparators are capable of doing precision work. The voltage comparator output stage looks like a very high open loop gain stage that has its output clamped to the power supply rails. There are other forms of the output stage which have two leads, and they enable the circuit designer to connect the output to two different voltage levels. This type of comparator is useful when the input must sense signals over a wide voltage range including negative voltages, and the output voltage swing must be compatible with a specific logic family.

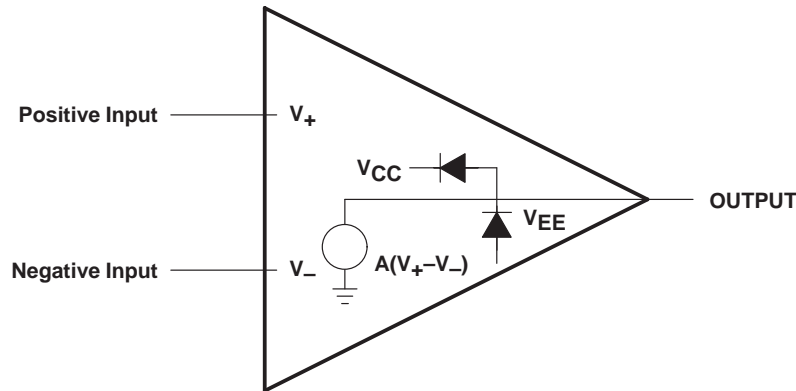

**Figure 9. Voltage Comparator Model**

## Other Active Devices

There are many more active devices than are covered in this application report. The exposure here is limited to the most popular devices, and these devices are adequate to cover the large majority of electronic equipment applications.



Specialty fields like power supplies, motor controls, data transmission, etc. have active devices not shown here. Rather than turn this application report into a two hundred-page collection of active devices, 99 percent of which are of little or no interest to the average reader, the author chose to ignore 99 percent. If you have a need for further information on an active device, mentioned or not mentioned here, contact the manufacturer. For example, if you contact the local TI sales office or the factory in Dallas, and ask for information on current feedback op amps, TI will send you information gratis. If you contact the local analog field specialist, they will see that you are sent data sheets and applications literature.

This application note is purposely kept brief, but the manufacturer's support system is more than happy to flood you with information. If you can't get information from a manufacturer, maybe you are talking to the wrong manufacturer.

## Summary

Active devices have gain, so they perform functions that passive devices can't fill. Active devices have voltage, current, and power gain; hence, when active devices are coupled with passive devices the combination fulfills all circuit requirements.

Active devices employ feedback to control the gain, and the feedback makes active devices dependent on passive device parameters. Accept this for now, because later applications will illustrate the concept. Feedback brings its own problems as well as its advantages. Oscillation resulting from misapplied feedback is the major disadvantage of active circuits.

A list of parameters of the three major amplifiers is shown in the table below and allows a quick comparison of their differences.

AMPLIFIER TYPE	INPUT IMPEDANCES		OUTPUT IMPEDANCE	BANDWIDTH	USES OF FEEDBACK FOR STABILITY	PRECISION CIRCUITS	USES
	Z <sub>IN+</sub>	Z <sub>IN-</sub>	Z <sub>OUT</sub>				
Voltage follower	High	High	Low	MHz	Yes	Yes	All types of circuits
Current feedback amplifier	High	Low	Low	GHz	Yes	No <sup>†</sup>	High frequency circuits
Comparator	High	High	Low	MHz	No	Yes	Transfer analog signals to digital

<sup>†</sup> Normally used in high frequency circuits where high dc precision is not important.

## **IMPORTANT NOTICE**

Texas Instruments and its subsidiaries (TI) reserve the right to make changes to their products or to discontinue any product or service without notice, and advise customers to obtain the latest version of relevant information to verify, before placing orders, that information being relied on is current and complete. All products are sold subject to the terms and conditions of sale supplied at the time of order acknowledgment, including those pertaining to warranty, patent infringement, and limitation of liability.

TI warrants performance of its semiconductor products to the specifications applicable at the time of sale in accordance with TI's standard warranty. Testing and other quality control techniques are utilized to the extent TI deems necessary to support this warranty. Specific testing of all parameters of each device is not necessarily performed, except those mandated by government requirements.

Customers are responsible for their applications using TI components.

In order to minimize risks associated with the customer's applications, adequate design and operating safeguards must be provided by the customer to minimize inherent or procedural hazards.

TI assumes no liability for applications assistance or customer product design. TI does not warrant or represent that any license, either express or implied, is granted under any patent right, copyright, mask work right, or other intellectual property right of TI covering or relating to any combination, machine, or process in which such semiconductor products or services might be or are used. TI's publication of information regarding any third party's products or services does not constitute TI's approval, warranty or endorsement thereof.